

SEMIPACK® 3 Rectifier Diode Modules

SKKD 201 **SKKE 201**
SKKD 260 **SKKE 260**
SKMD 260¹⁾

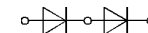

SKKD



SKKE

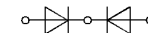

SKMD

Features

- Heat transfer through aluminium nitride ceramic isolated metal baseplate
- Precious metal pressure contacts
- **SKKD** half bridge connection
SKMD center-tap connection common cathode
- UL recognized, file no. E 63 532

Typical Applications

- Non-controllable rectifiers for AC/AC converters
- Line rectifiers for transistorized AC motor controllers
- Field supply for DC motors
- SKKE: Free-wheeling diodes

V _{RSM}	V _{RRM}	I _{FRMS} (maximum values for continuous operation)			
		315 A	410 A	315 A	410 A
V	V	I _{FAV} (sin. 180; T _{case} = 80 °C)			
		200 A	260 A	200 A	260 A
900	800	SKKD 201/08	SKKD 260/08	SKKE 201/08	–
1300	1200	SKKD 201/12	SKKD 260/12	SKKE 201/12	SKKE 260/12
1500	1400	SKKD 201/14	SKKD 260/14	SKKE 201/14	SKKE 260/14
1700	1600	SKKD 201/16	SKKD 260/16	SKKE 201/16	SKKE 260/16
2100	2000	SKKD 201/20	SKKD 260/20	SKKE 201/20	SKKE 260/20
2300	2200	SKKD 201/22	SKKD 260/22	SKKE 201/22	SKKE 260/22

Symbol	Conditions	SKKD 201 SKKE 201	SKKD 260 SKKE 260	Units
I _{FAV} I _D ¹⁾	sin. 180; T _{case} = 85 °C B2/B6 T _{amb} = 35 °C; P 3/180 F P 16/200 F	200 250/295 385/515	260 280/320 490/655	A A A
I _{FSM}	T _{vj} = 25 °C; 10 ms T _{vj} = 130 °C; 10 ms	6 000 5 000	11 000 10 000	A A
i ² t	T _{vj} = 25 °C; 8,3 ... 10 ms T _{vj} = 130 °C; 8,3 ... 10 ms	180 000 125 000	605 000 500 000	A ² s A ² s
I _{RD}	T _{vj} max.; V _{RD} = V _{RRM}	9	15	mA
V _F	T _{vj} = 25 °C (I _F = . . .); max.	1,35 (600 A)	1,25 (750 A)	V
V _(TO)	T _{vj} = 130 °C	0,80	0,90	V
r _T	T _{vj} = 130 °C	0,8	0,37	mΩ
R _{thjc} R _{thch} T _{vj} T _{stg}	} per diode/per module ²⁾	0,19/0,10 0,06/0,03	0,14/0,07 0,04/0,02	°C/W °C/W
			– 40 ... +130	°C
			– 40 ... +130	°C
V _{isol} M ₁ M ₂ a w	a. c. 50 Hz; r.m.s.; 1 s/1 min to heatsink to terminals approx.	SI units US units SI units US units	3600/3000 5 ± 15 % ³⁾ 44 ± 15 % ³⁾ 9 ± 15 % ⁴⁾ 80 ± 15 % ⁴⁾ 5 · 9,81 800	V~ Nm lb.in. Nm lb.in. m/s ² g
Case	→ page B 1 – 74	SKKD 201 SKKE 201	A 16 A 17	
	→ page B 1 – 80	SKKD 260 SKKE 260 SKMD 260		A 27 A 28 A 58

- 1) SKMD 260 available on request
2) SKKD types only
3) See the assembly instructions
4) The screws must be lubricated

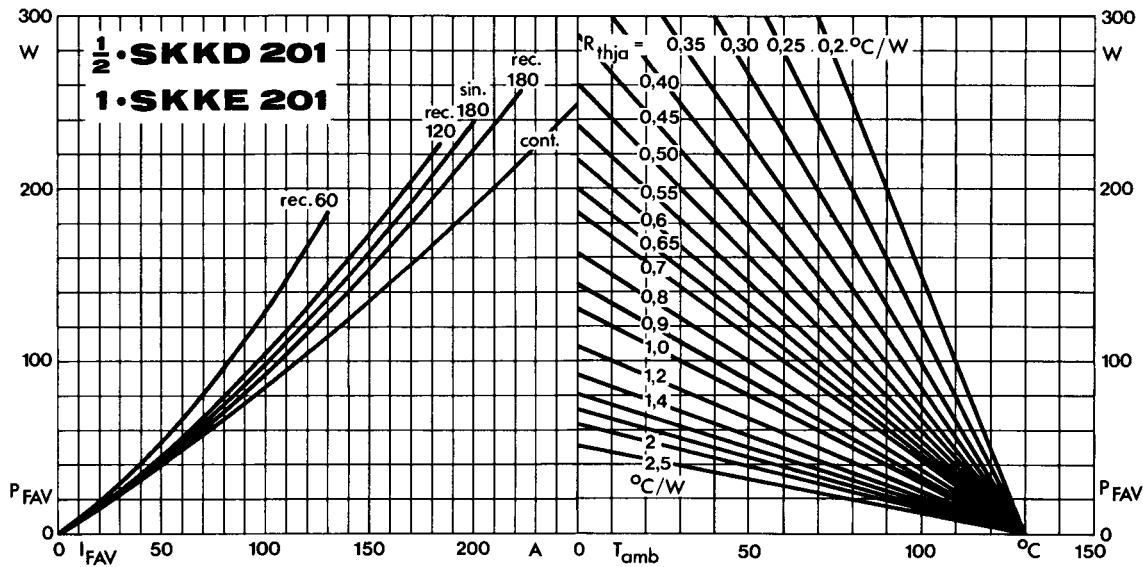

Fig. 11 a Power dissipation per diode vs. forward current and ambient temperature

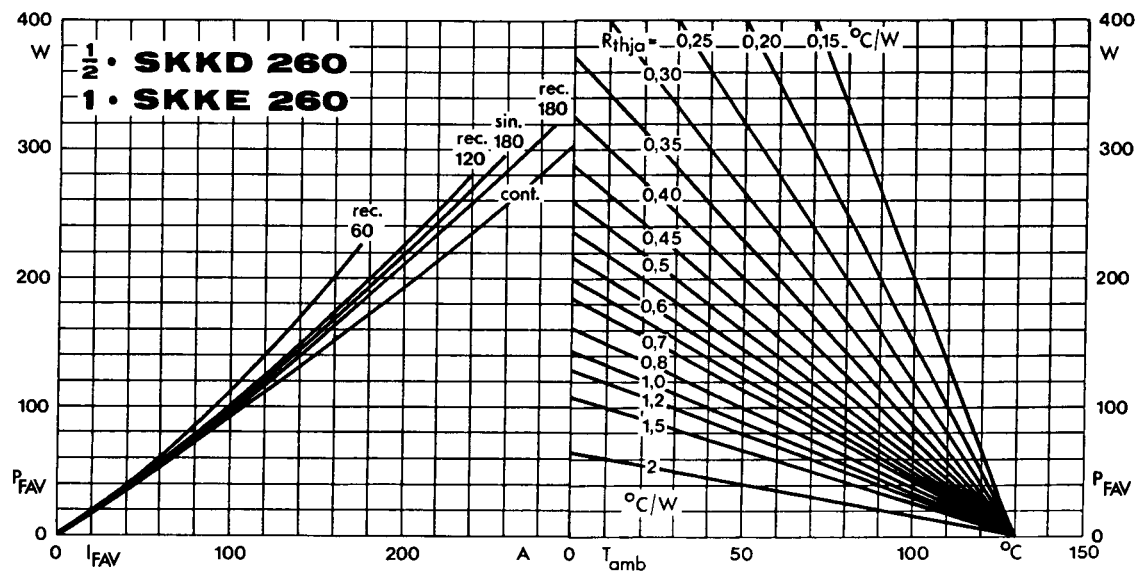

Fig. 11 b Power dissipation per diode vs. forward current and ambient temperature

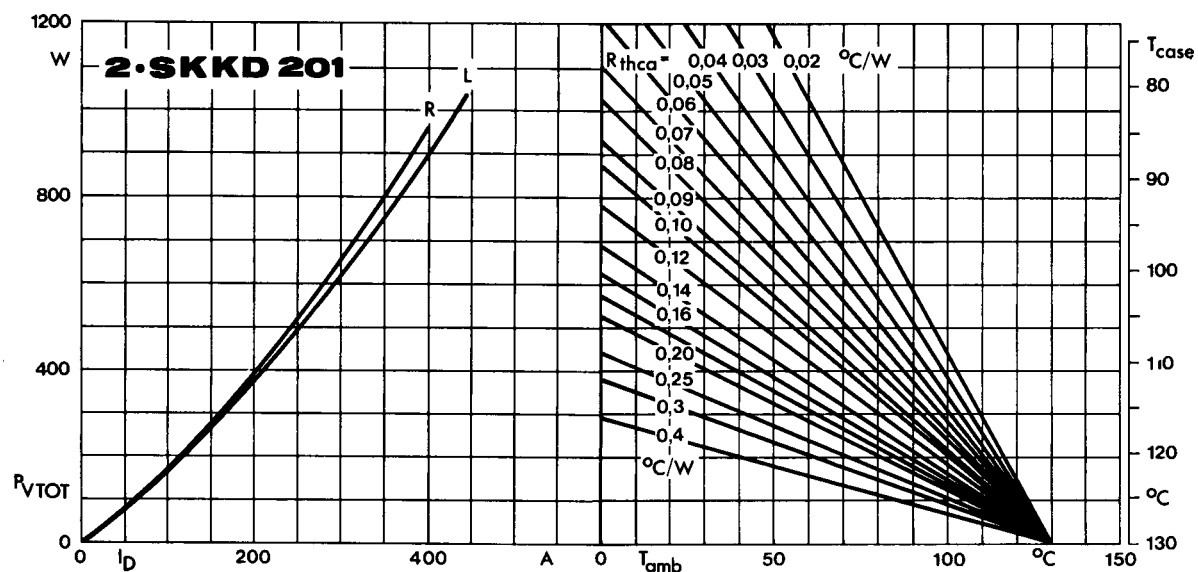

Fig. 12 a Power dissipation of two modules vs. direct current and case temperature

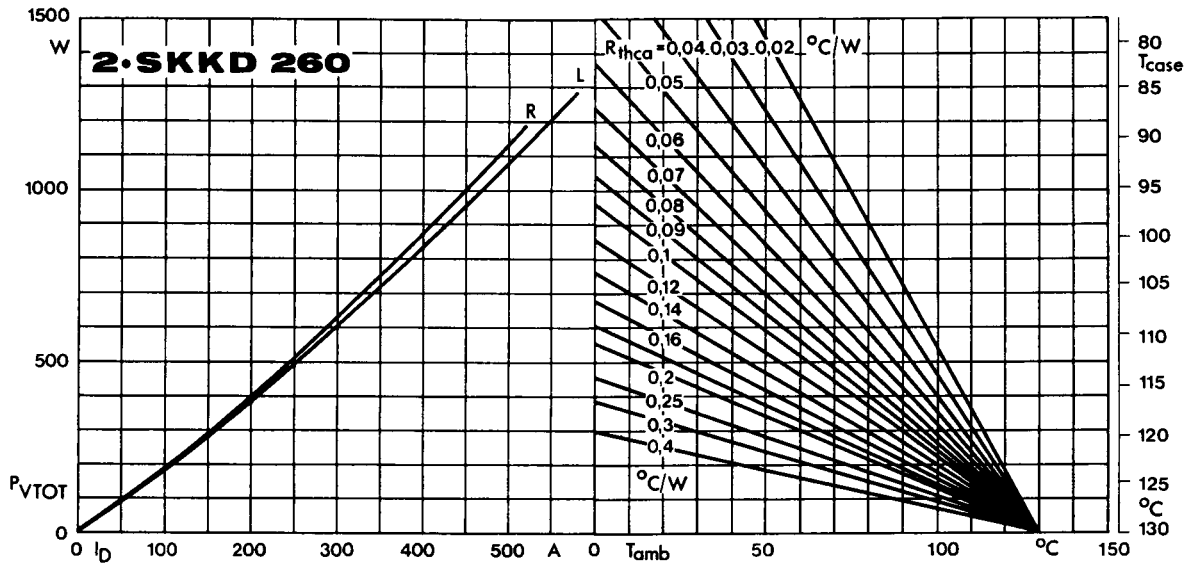

Fig. 12 b Power dissipation of two modules vs. direct current and case temperature

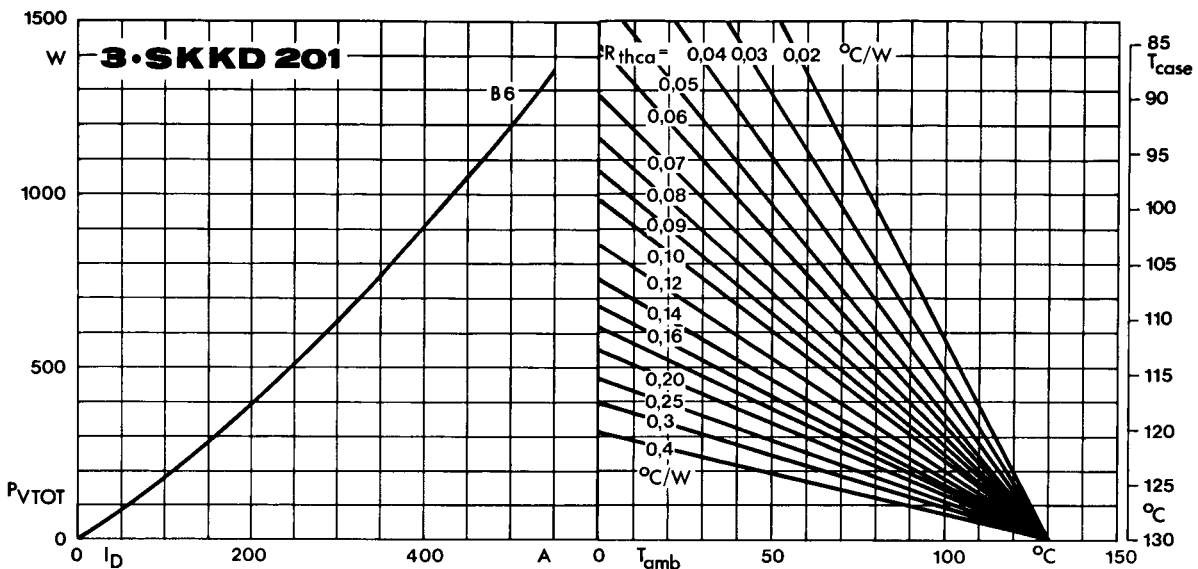

Fig. 13 a Power dissipation of three modules vs. direct current and case temperature

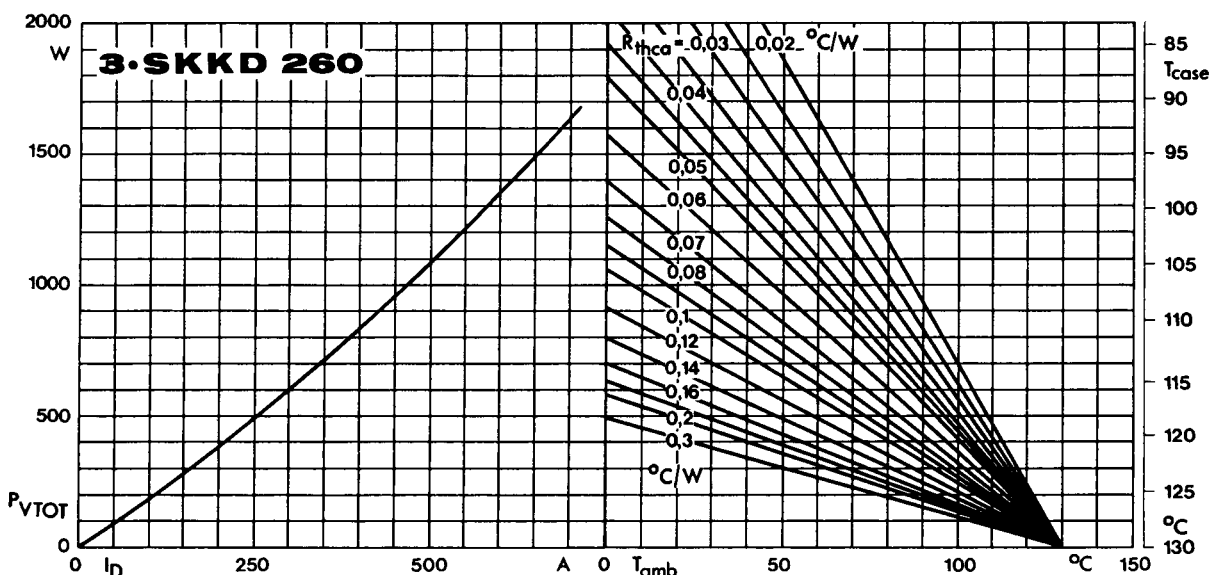

Fig. 13 b Power dissipation of three modules vs. direct current and case temperature

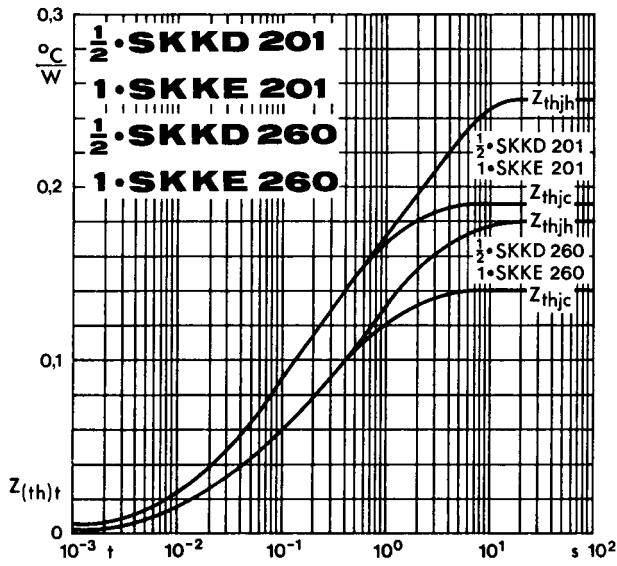

Fig. 14 Transient thermal impedance vs. time

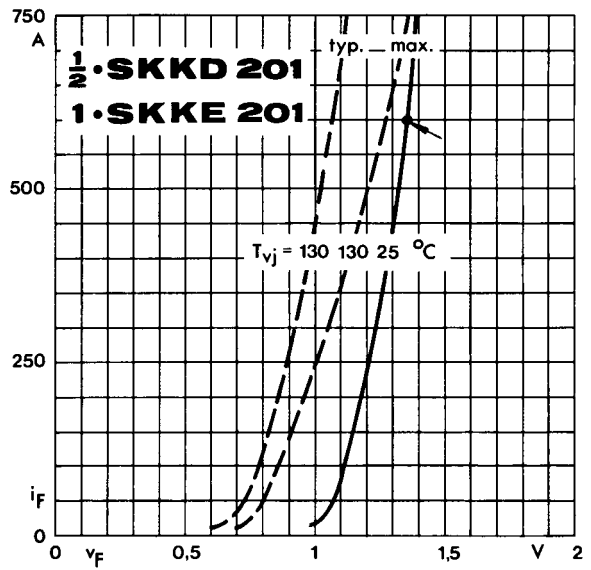

Fig. 15 a Forward characteristics

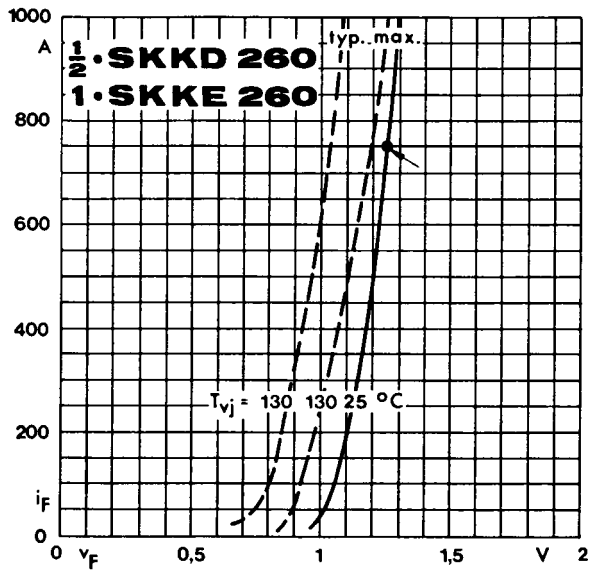

Fig. 15 b Forward characteristics

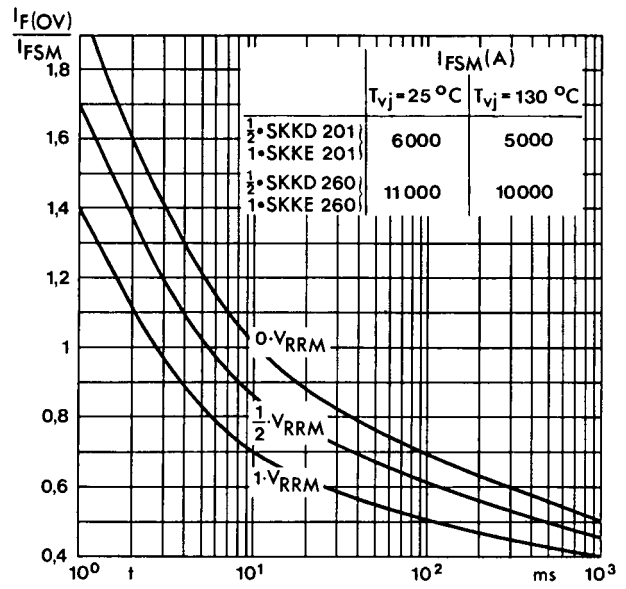
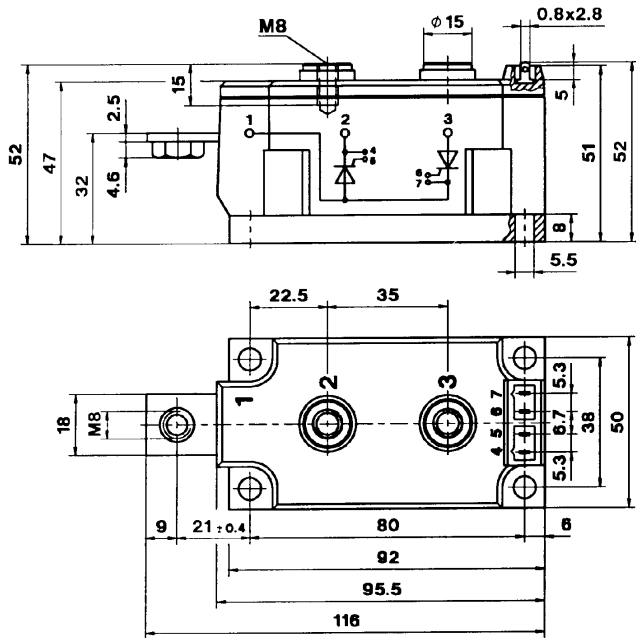

Fig. 16 Surge overload current vs. time

SKKT 131, SKKT 161

Case A 13

SEMIPACK 3 UL recognized, file no. E 63 532



SKKL 131, SKKL 161

Case A 15

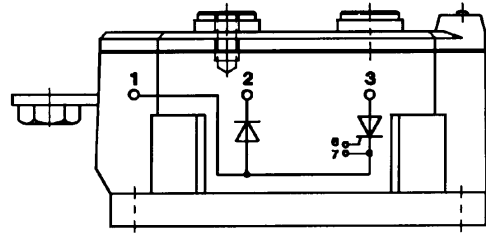

SKKD 201

Case A 16

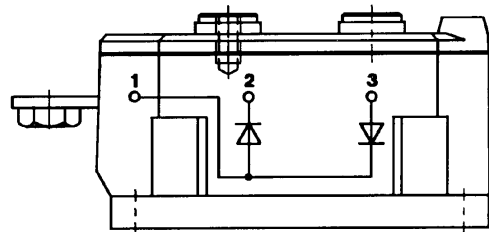

SKKH 131, SKKH 161

Case A 14

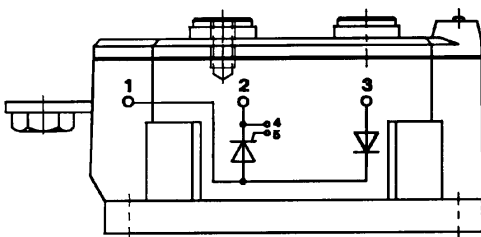

SKKE 201

Case A 17

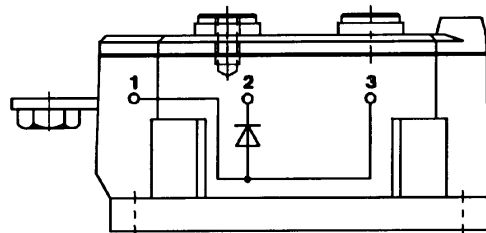

Dimensions in mm

SKKT 210, SKKT 250

Case A 25

SEMIPACK 3

UL recognized, file no. E 63 532

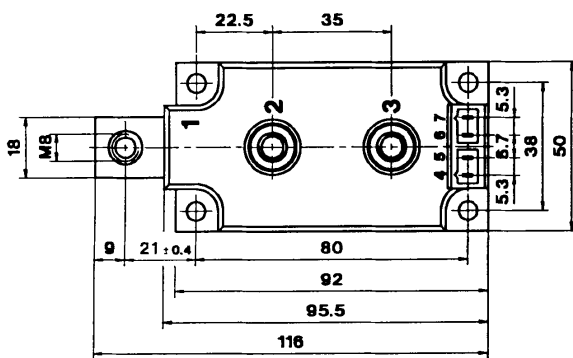
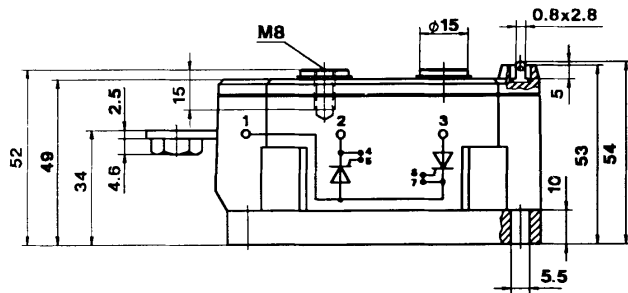

SKKH 210, SKKH 250

Case A 26

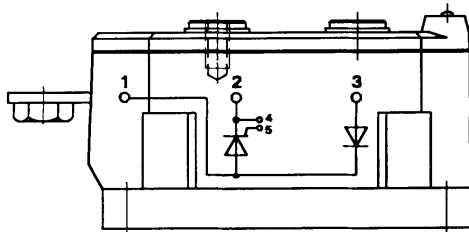

SKKD 260

Case A 27

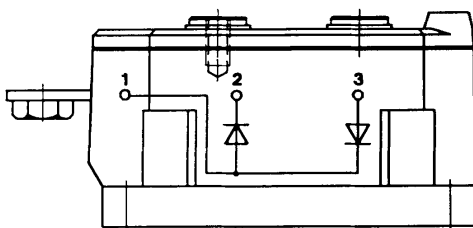

SKKE 260

Case A 28

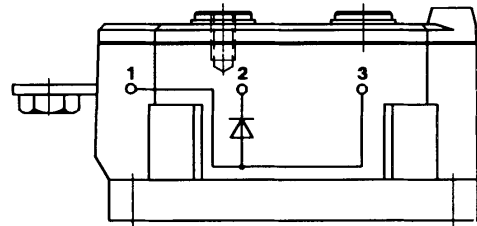

SKKL 210, SKKL 250

Case A 35

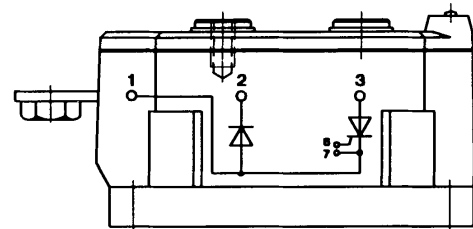

SKMD 260

Case A 58

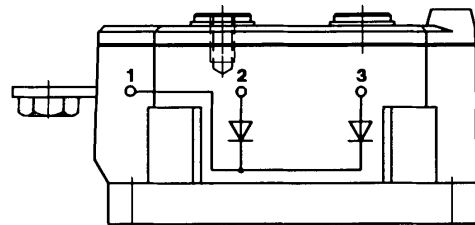

SKMT 250

Case A 64

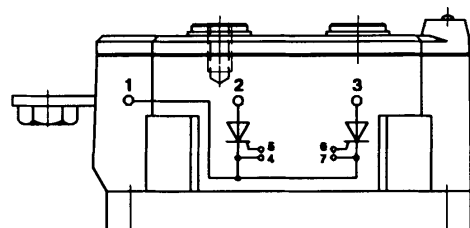

Dimensions in mm