

Absolute Maximum Ratings		Values		Units
Symbol	Conditions ¹⁾			
V _{CES}		1700		V
V _{CGR}	R _{GE} = 20 kΩ	1700		V
I _C	T _{case} = 25/80 °C	220 / 150		A
I _{CM}	T _{case} = 25/80 °C; t _p = 1 ms	440 / 300		A
V _{GES}		± 20		V
P _{tot}	per IGBT, T _{case} = 25 °C	1250		W
T _j , (T _{stg})		- 40 ... +150 (125)		°C
V _{isol}	AC, 1 min.	4000		V
humidity	DIN 40 040	Class F		
climate	DIN IEC 68 T.1	40/125/56		
Inverse Diode ⁸⁾		"FWD; D1" ⁶⁾		
I _F = - I _C	T _{case} = 25/80 °C	150 / 100	230 / 150	A
I _{FM} = - I _{CM}	T _{case} = 25/80 °C; t _p = 1 ms	400 / 300	400 / 300	A
I _{FSM}	t _p = 10 ms; sin.; T _j = 150 °C	1450	2200	A
I _t ²	t _p = 10 ms; T _j = 150 °C	10500	24000	A ² s

Characteristics		min.	typ.	max.	Units		
Symbol	Conditions ¹⁾						
V _{(BR)CES}	V _{GE} = 0, I _C = 3 mA	≥ V _{CES}	-	-	V		
V _{GE(th)}	V _{GE} = V _{CE} , I _C = 10 mA	4,8	5,5	6,2	V		
I _{CES}	V _{GE} = 0 } T _j = 25 °C	-	-	1,5	mA		
		V _{CE} = V _{CES} } T _j = 125 °C	-	-	4,5	mA	
I _{GES}	V _{GE} = 20 V, V _{CE} = 0 V	-	-	400	nA		
V _{CEsat}	I _C = 150 A } V _{GE} = 15 V;	-	3,4(4,5)	3,9(5)	V		
V _{CEsat}	I _C = 200 A } T _j = 25 (125) °C	-	3,8(5,5)	-	V		
g _{fs}	V _{CE} = 20 V, I _C = 150 A	54	-	-	S		
C _{CHC}	per IGBT	-	-	200	pF		
C _{ies}	} V _{GE} = 0	-	20	-	nF		
C _{oes}		} V _{CE} = 25 V	-	2	-	nF	
C _{res}			f = 1 MHz	-	0,55	-	nF
L _{CE}		-	-	20	nH		
t _{d(on)}	} V _{CC} = 1200 V	-	580	-	ns		
t _r		} V _{GE} = + 15 V / - 15 V	-	100	-	ns	
t _{d(off)}			} I _C = 150 A, ind. load	-	750	-	ns
t _f		} R _{Gon} = R _{Goff} = 4 Ω		-	40	-	ns
E _{on}				} T _j = 125 °C	-	95	-
E _{off}					-	45	-
Inverse Diode ⁸⁾							
V _F = V _{EC}	I _F = 150 A } V _{GE} = 0 V;	-	2,2(1,9)	2,7	V		
V _F = V _{EC}		I _F = 200 A } T _j = 25 (125) °C	-	2,4(2,2)	-	V	
V _{TO}	T _j = 125 °C	-	1,3	1,5	V		
r _T	T _j = 125 °C	-	4,5	6,2	mΩ		
I _{RR}	I _F = 150 A; T _j = 25 (125) °C ²⁾	-	60(85)	-	A		
Q _{rr}	I _F = 150 A; T _j = 25 (125) °C ²⁾	-	15(38)	-	μC		
FWD of types "GAL, GAR, D1" ^{6) 8)}							
V _F = V _{EC}	I _F = 150 A } V _{GE} = 0 V;	-	2,0(1,8)	2,4	V		
V _F = V _{EC}		I _F = 200 A } T _j = 25 (125) °C	-	2,2(2,0)	-	V	
V _{TO}	T _j = 125 °C	-	1,3	1,5	V		
r _T	T _j = 125 °C	-	3,5	4,5	mΩ		
I _{RR}	I _F = 150 A; T _j = 25 (125) °C ²⁾	-	75(110)	-	A		
Q _{rr}	I _F = 150 A; T _j = 25 (125) °C ²⁾	-	20(50)	-	μC		
Thermal Characteristics							
R _{thjc}	per IGBT	-	-	0,1	°C/W		
R _{thjc}	per diode D/"GAL, GAR, D1"	-	-	0,32/0,21	°C/W		
R _{thch}	per module	-	-	0,038	°C/W		

SEMITRANS® M IGBT Modules

SKM 200 GB 173 D
 SKM 200 GB 173 D1 ⁶⁾
 SKM 200 GAL 173 D ⁶⁾
 SKM 200 GAR 173 D ⁶⁾



SEMITRANS 3

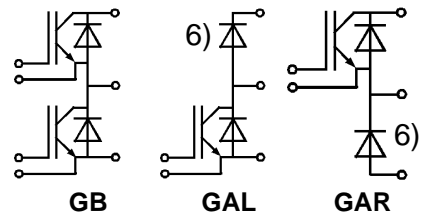

Features

- MOS input (voltage controlled)
- N channel, Homogeneous Si
- Low inductance case
- Very low tail current with low temperature dependence
- High short circuit capability, self limiting to 6 * I_{cnom}
- Latch-up free
- Fast & soft inverse CAL diodes⁸⁾
- Isolated copper baseplate using DCB Direct Copper Bonding
- Large clearance (13 mm) and creepage distances (20 mm).

Typical Applications:

- AC inverter drives on mains 575 - 750 V_{AC}
- DC bus voltage 750 - 1200 V_{DC}
- Public transport (auxiliary syst.)
- Switching (not for linear use)

1) T_{case} = 25 °C, unless otherwise specified

2) I_F = - I_C, V_R = 1200 V, - di_F/dt = 1000 A/μs, V_{GE} = 0 V

6) The free-wheeling diodes of the GAL, GAR and D1 types have the data of the inverse diodes of SKM 300 GA 173 D

8) CAL = Controlled Axial Lifetime Technology.

Cases and mech. data → B6-258

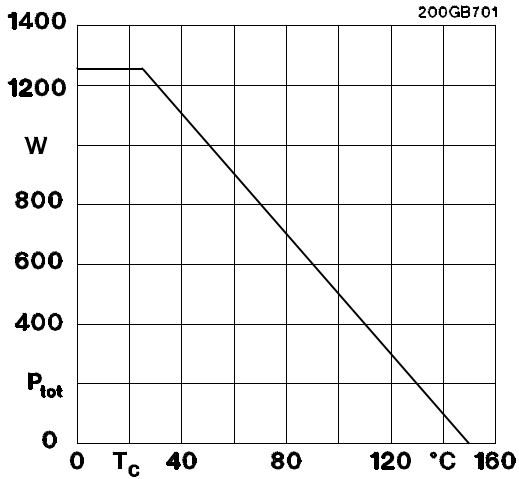

Fig. 1 Rated power dissipation $P_{tot} = f(T_c)$

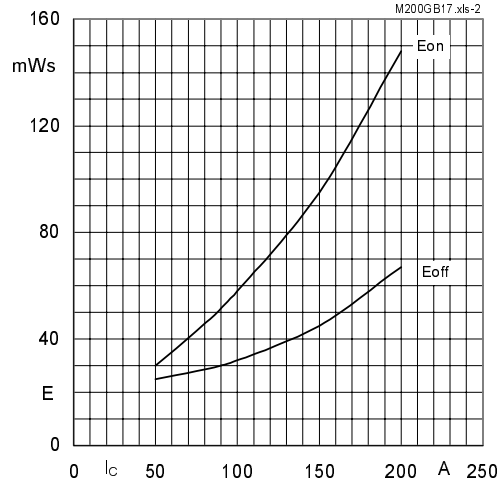

Fig. 2 Turn-on /-off energy $= f(I_c)$

$T_j = 125\text{ }^\circ\text{C}$
 $V_{CE} = 1200\text{ V}$
 $V_{GE} = \pm 15\text{ V}$
 $R_G = 4\text{ }\Omega$

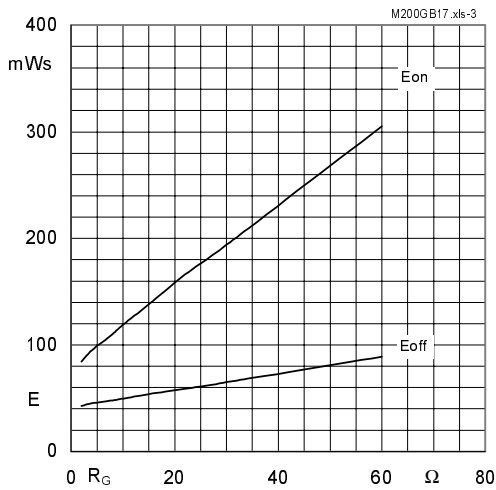

Fig. 3 Turn-on /-off energy $= f(R_G)$

$T_j = 125\text{ }^\circ\text{C}$
 $V_{CE} = 1200\text{ V}$
 $V_{GE} = \pm 15\text{ V}$
 $I_C = 150\text{ A}$

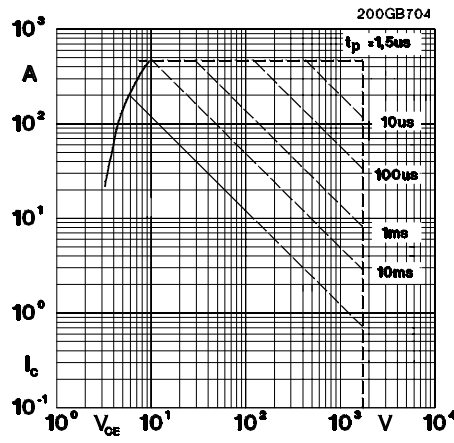

Fig. 4 Maximum safe operating area (SOA) $I_c = f(V_{CE})$

1 pulse
 $T_C = 25\text{ }^\circ\text{C}$
 $T_j \leq 150\text{ }^\circ\text{C}$

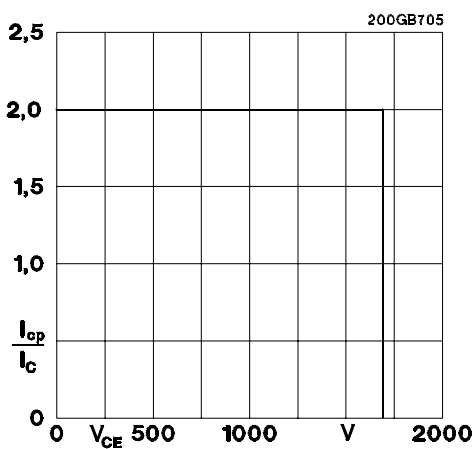

Fig. 5 Turn-off safe operating area (RBSOA)

$T_j \leq 150\text{ }^\circ\text{C}$
 $V_{GE} = \pm 15\text{ V}$
 $R_{Goff} = 4\text{ }\Omega$
 $I_C = 150\text{ A}$

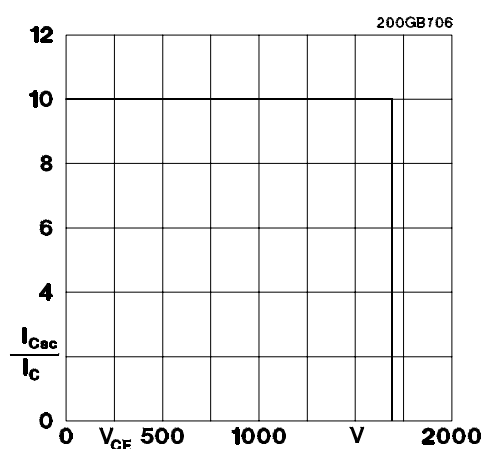
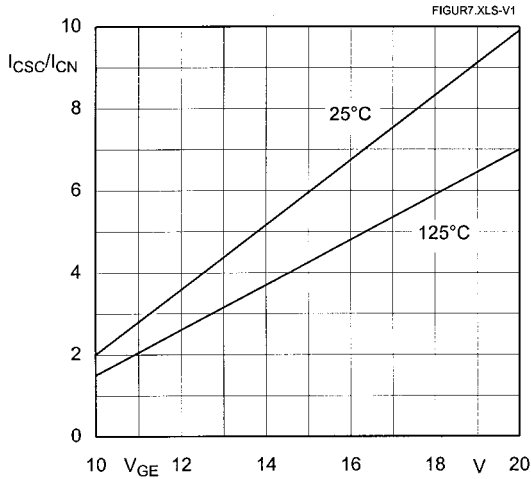

Fig. 6 Safe operating area at short circuit $I_c = f(V_{CE})$

$T_j \leq 150\text{ }^\circ\text{C}$
 $V_{GE} = \pm 15\text{ V}$
 $t_{sc} \leq 10\text{ }\mu\text{s}$
 $L_{ext} < 50\text{ nH}$
 $I_C = 150\text{ A}$



$V_{CC} = 1200 \text{ V}$
 $I_C = 150 \text{ A}$
 $R_G = 4 \text{ } \Omega$
 $L_{ext} \leq 50 \text{ nH}$
 self-limiting
 $t_p = 10 \text{ } \mu\text{s}$

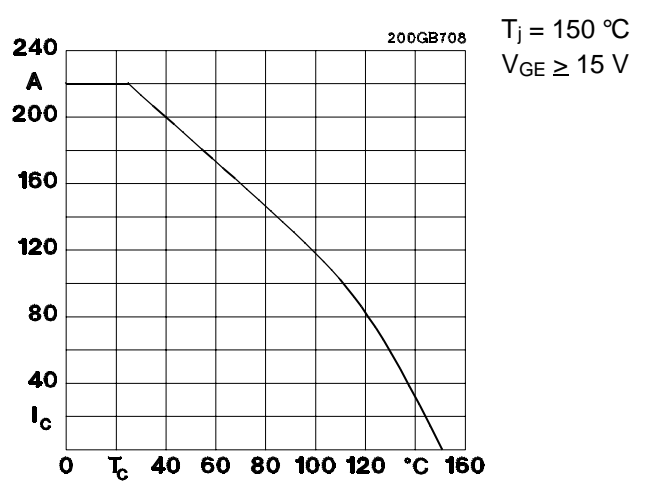

Fig. 7 Short circuit current vs. turn-on gate voltage

Fig. 8 Rated current vs. temperature $I_C = f(T_C)$

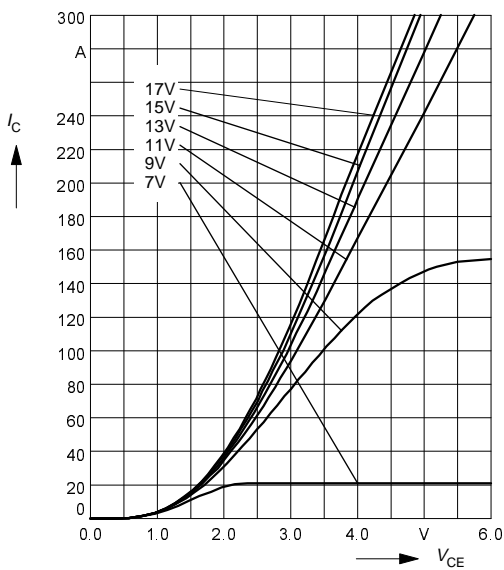

Fig. 9 Typ. output characteristic, $t_p = 80 \text{ } \mu\text{s}$; $T_j = 25 \text{ } ^\circ\text{C}$

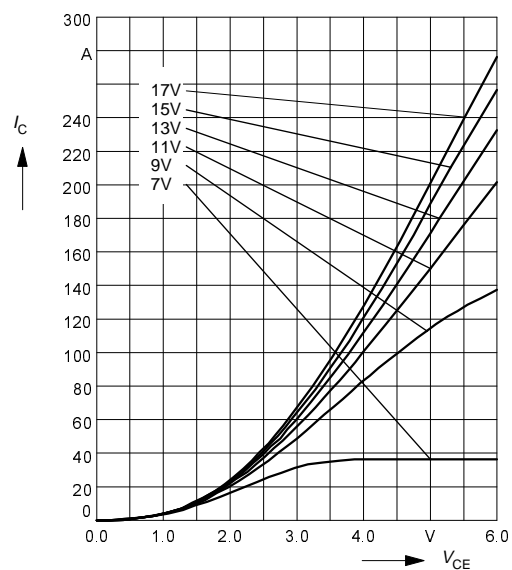

Fig. 10 Typ. output characteristic, $t_p = 80 \text{ } \mu\text{s}$; $T_j = 125 \text{ } ^\circ\text{C}$

$$P_{cond}(t) = V_{CEsat}(t) \cdot I_C(t)$$

$$V_{CEsat}(t) = V_{CE(TO)(T_j)} + r_{CE(T_j)} \cdot I_C(t)$$

$$V_{CE(TO)(T_j)} \leq 1,9 + 0,003 (T_j - 25) \text{ [V]}$$

$$r_{CE(T_j)} = 0,011 + 0,00004 (T_j - 25) \text{ [}\Omega\text{]}$$

valid for $V_{GE} = +15 \begin{smallmatrix} +2 \\ -1 \end{smallmatrix} \text{ [V]}$; $I_C \geq 0,3 I_{Cnom}$

Fig. 11 Typ. saturation characteristic (IGBT)
Calculation elements and equations

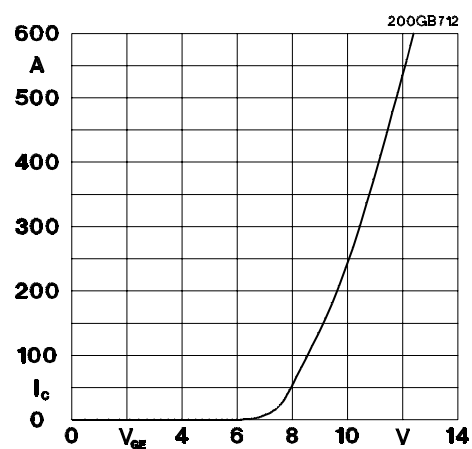

Fig. 12 Typ. transfer characteristic, $t_p = 80 \text{ } \mu\text{s}$; $V_{CE} = 20 \text{ V}$

$I_{cpuls} = 150 \text{ A}$

$V_{GE} = 0 \text{ V}$
 $f = 1 \text{ MHz}$

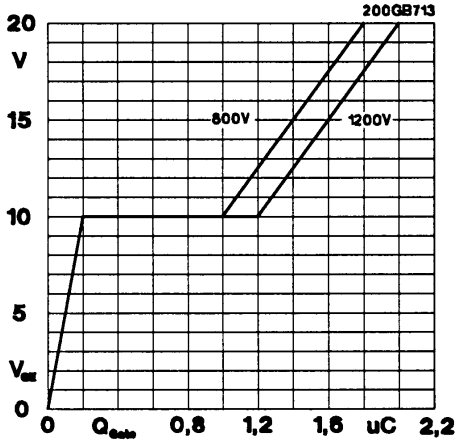

Fig. 13 Typ. gate charge characteristic

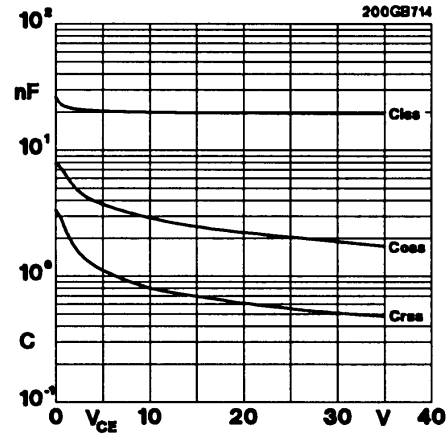

Fig. 14 Typ. capacitances vs. V_{CE}

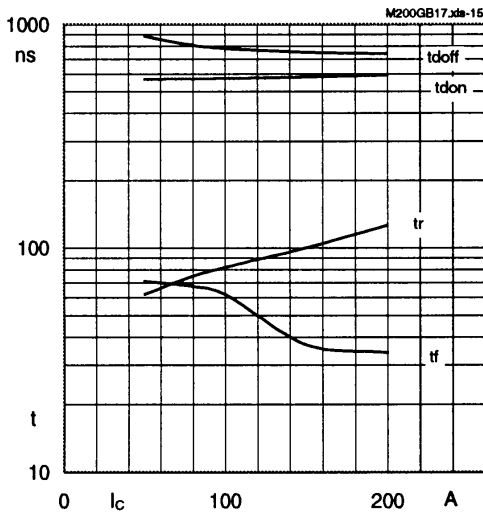
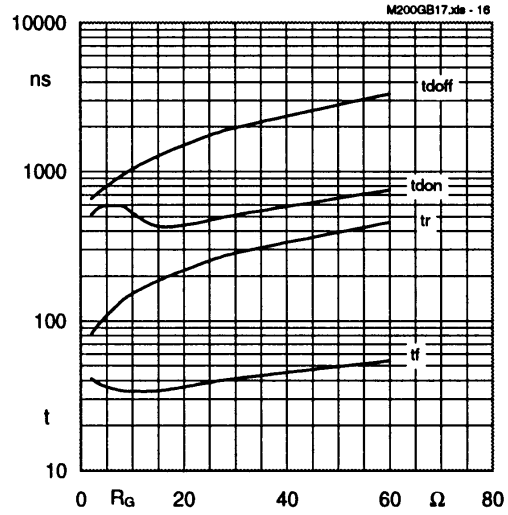

Fig. 15 Typ. switching times vs. I_c

$T_j = 125 \text{ }^\circ\text{C}$
 $V_{CC} = 1200 \text{ V}$
 $V_{GE} = \pm 15 \text{ V}$
 $R_g = 4 \text{ } \Omega$



$T_j = 125 \text{ }^\circ\text{C}$
 $V_{CC} = 1200 \text{ V}$
 $V_{GE} = \pm 15 \text{ V}$
 $I_c = 150 \text{ A}$

Fig. 16 Typ. switching times vs. R_G

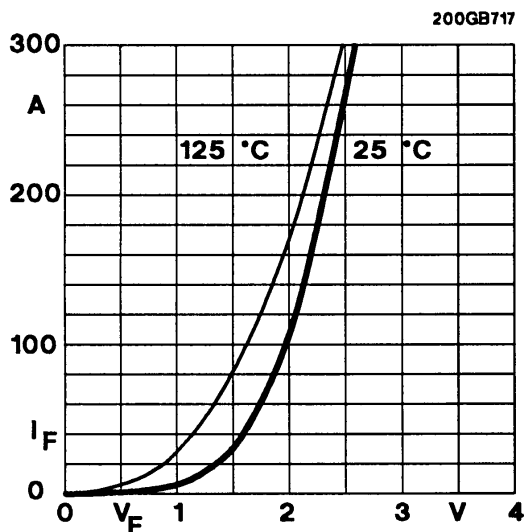

Fig. 17 Typ. CAL diode forward characteristic

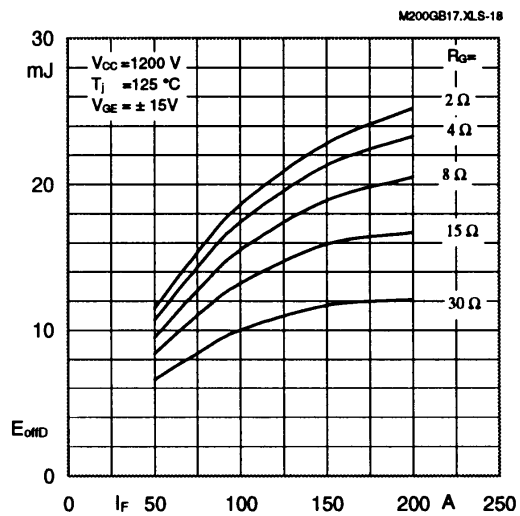

Fig. 18 Typ. Diode turn-off energy dissipation per pulse

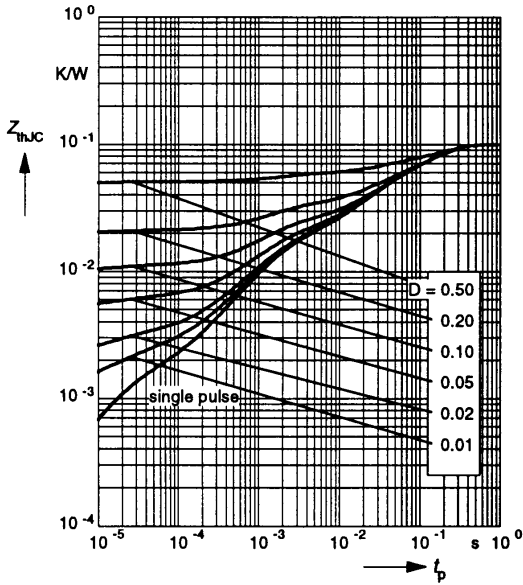

Fig. 19 Transient thermal impedance of IGBT: $Z_{thjC} = f(t_p)$; $D = t_p / t_c = t_p \cdot f$

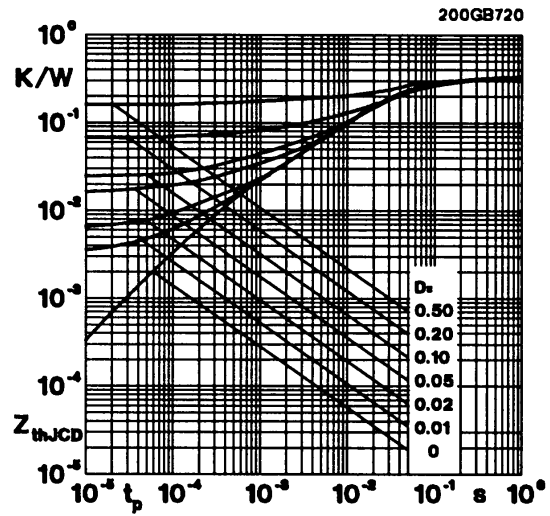

Fig. 20 Transient thermal impedance of inverse diode: $Z_{thjCD} = f(t_p)$

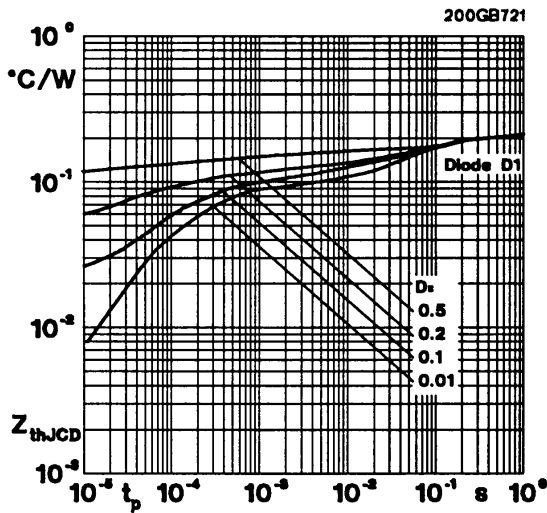

Fig. 21 Transient thermal impedance of FWD of SKM 200GAL173D: $Z_{thjCD} = f(t_p)$

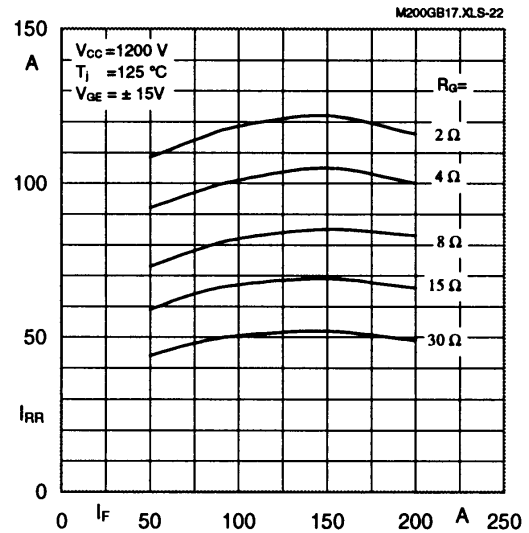

Fig. 22 Typ. CAL diode peak reverse recovery current of inverse diode $I_{RR} = f(I_F; R_G)$

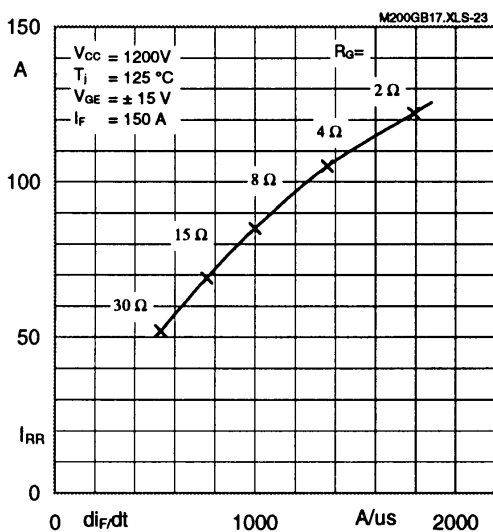

Fig. 23 Typ. CAL diode peak reverse recovery current of inverse diode: $I_{RR} = f(di_F/dt)$

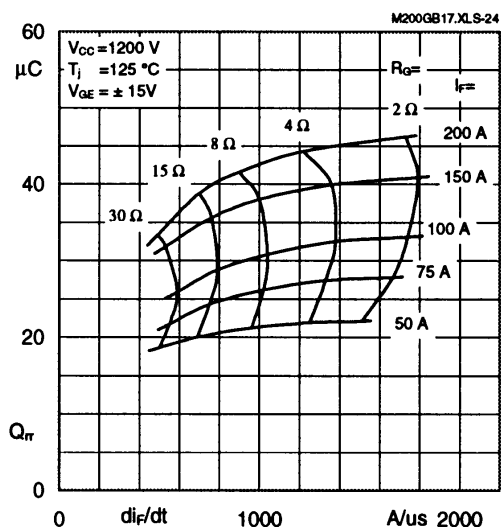

Fig. 24 Typ. CAL diode recovered charge Q_{rr} of inverse diode

SEMITRANS 3

Case D 56

UL Recognized

File no. E 63 532

CASED56

SKM 200 GB 123 D

SKM 200 GB 173 D

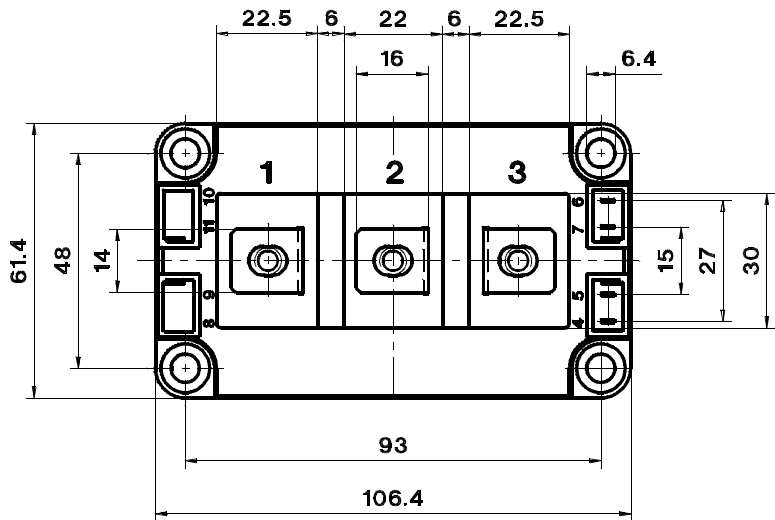
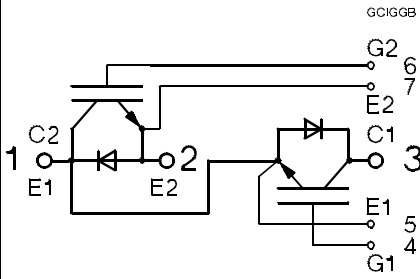
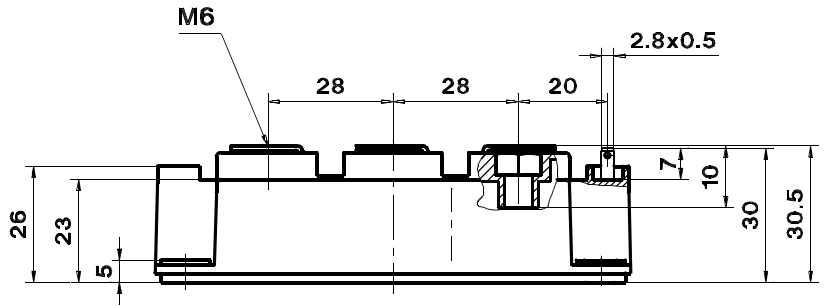

Dimensions in mm

SKM 150 GAL 123 D

SKM 200 GAL 123 D

SKM 200 GAL 173 D

Case D 57 (→ D 56)

GCIGGAL

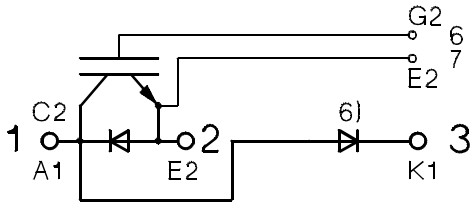

SKM 150 GAR 123 D

SKM 200 GAR 123 D

SKM 200 GAR 173 D

Case D 58 (→ D 56)

GCIGGAR

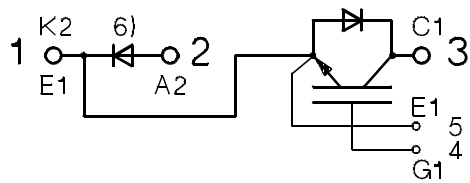

Case outline and circuit diagrams

For SKM 200 GA 123 D (SEMITRANS 4) → B 6 - 168

Mechanical Data

Symbol	Conditions		Values			Units
			min.	typ.	max.	
M ₁	to heatsink, SI Units	(M6)	3	—	5	Nm
	to heatsink, US Units		27	—	44	lb.in.
M ₂	for terminals, SI Units	(M6)	2,5	—	5	Nm
	for terminals US Units		22	—	44	lb.in.
a			—	—	5x9,81	m/s ²
w			—	—	325	g

This is an electrostatic discharge sensitive device (ESDS). Please observe the international standard IEC 747-1, Chapter IX.

Three devices are supplied in one SEMIBOX A without mounting hardware, which can be ordered separately under Ident No. 33321100 (for 10 SEMITRANS 3). Larger packing units of 12 and 20 pieces are used if suitable

Accessories → B 6 - 4.
SEMIBOX → C - 1.

⁶⁾ Freewheeling diode → B 6 - 253, remark 6.